

EEPROM

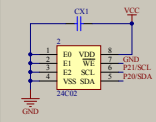

无线接口



138译码器

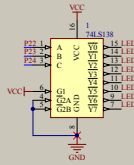

数码管

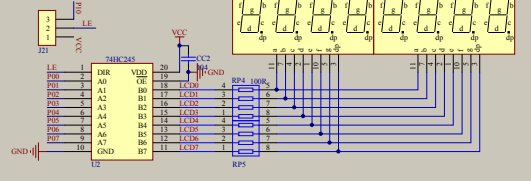

AD/DA/光敏

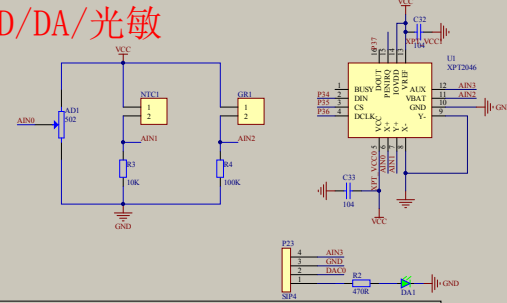

LED点阵

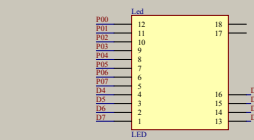

五线四相步进电机

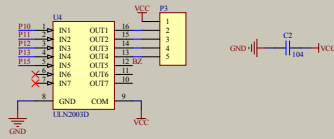

74HC595

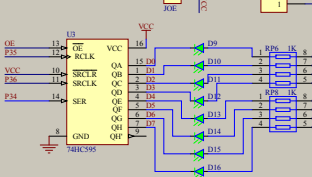

超声波测距模块接口

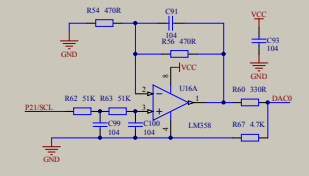

MCU

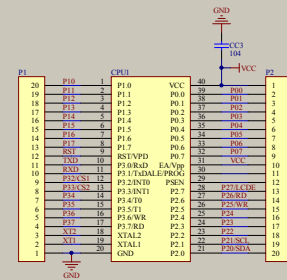

Lcd12864

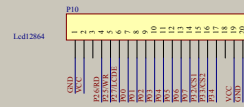

Lcd1602

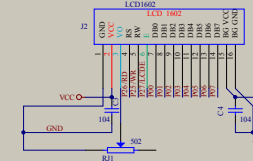

DS1302

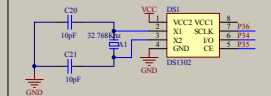

复位

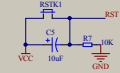

ISP

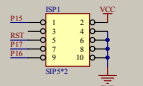

USB自动下载电路

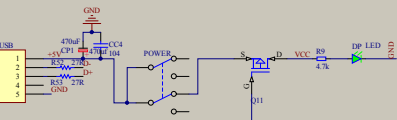

蜂鸣器



温度

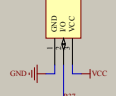

红外

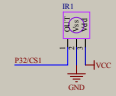

独立按键

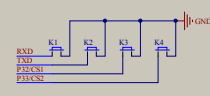

矩阵按键

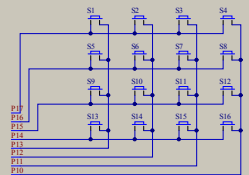

LED模块

